



S8

Compact size and high performance for the most challenging detection applications

- Compact dimensions (14x42x25 mm)
- Background suppression for transparent and shiny objects
- Contrast sensors up to 10 kHz switching frequency
- Extremely focused spot, under 1 mm (LASER model)
- Very high resolution LASER models
- INOX AISI 316L model



SENSORS

APPLICATIONS

- Processing and Packaging machinery
- Beverage/Food/ Cosmetics/ Pharmaceutical industries
- Electronics assembling



(*) Stainless steel models.
ATEX II 3DG

S8		
Through beam		0...25 m
Polarized retroreflective		0,1...5 m
Retroreflective for transparent (coaxial)		0...10 m (class 2 LASER)
Diffuse proximity		0...0,8 m (T51), 0...2 m (T53, T50)
Background suppression		0...500 mm
Background suppression for clear detection		50...300 mm
Contrast sensor		20...200 mm (class 2 LASER)
Luminescence sensor		100...300 mm (LED)
		50...150 mm (class 2 LASER)
Power supply	Vdc	10 mm
	Vac	10...30 mm
	Vac/dc	10...30 V
Output	PNP	▪
	NPN	▪
	NPN/PNP	
	relay	
	other	
Connection	cable	▪
	connector	▪
	pig-tail	▪
Approximate dimensions (mm)		14x42x25
Housing material		ABS, Stainless Steel AISI 316L
Mechanical protection		IP69K (Stainless Steel vers.), IP67

TECHNICAL DATA	
Power supply	12 ... 30 Vdc (short-circuit protection)
Ripple	2 Vpp max.
Consumption (output current excluded)	30 mA; 35 mA (mod. S8...M01); 20 mA (mod. S8...F), 15 mA (mod. S8...G) max.
Light emission	red LED 660 nm (mod. S8...B/C/M/G/T) RGB LEDs: blue 465 nm, green 520 nm, red 630nm with automatic selection (mod. S8...W) UV LED 375 nm (mod. S8...U) red Laser 645..665 nm (mod. S8...B/M)
Setting	8-turn distance adjustment trimmer (mod. S8...M53/M) LIGHT / DARK mono-turn trimmer (mod. S8...B/C/F/T51) teach-in push button (mod. S8...M53/W03/W13/T53/U) remote input (mod. S8...W/U/T50/T53)
Operating mode	mono-turn trimmer (mod. S8...B/C/F/M/T/U/W13) automatic (mod. S8...W/T50) remote input (mod. S8...M53)
Indicators	yellow OUTPUT LED (excl. mod. S8...G), OUTPUT/ALARM LED (mod. S8...M53/M/C) green POWER LED
Output	PNP or NPN N.O.
Output current	100 mA (overload protection)
Saturation voltage	2 V max.
Response time	1 ms (mod. S8...M53/M) 500 µs (mod. S8...B/F/C) 250 µs (mod. S8...T) 100 µs (Laser vers. mod. S8...M) 50 µs (mod. S8...W00/W03 e Laser mod. S8...B) 20 µs (mod. S8...W13) 250 µs...1 ms (mod. S8...U)
Switching frequency	500 Hz (mod. S8...M53/M) 1 kHz (mod. S8...B/F/C) 2 kHz (mod. S8...T) 5 kHz (Laser vers. mod. S8...M) 10 kHz (mod. S8...W00/W03 e Laser mod. S8...B) 25 kHz (mod. S8...W13) 500 Hz...2 kHz (mod. S8...U)
Connection	M8 4-pole connector, 150 mm length Ø 4 mm cable with M12 4-pole connector (pig-tail vers.)
Dielectric strength	1500 VAC 1 min between electronic parts and housing
Insulating resistance	>20 MΩ 500 VDC between electronic parts and housing
Mechanical protection	IP67, IP69K (mod. S8-M)
Ambient light rejection	according to EN 60947-5-2
Vibrations	0.5 mm amplitude, 10 ... 55 Hz frequency, for every axis (EN60068-2-6)
Shock resistance	11 ms (30 G) 6 shocks per every axis (EN60068-2-27)
Housing material	ABS, Stainless Steel AISI316L
Lens material	window in PMMA; lens in PC
Operating temperature	-10 ... 55 °C
Storage temperature	-20 ... 70 °C
Weight	12 g max. conn. vers., 50 g pig-tail vers., 70 g max. (mod. S8-M)

CONNECTIONS

M12 PIGTAIL

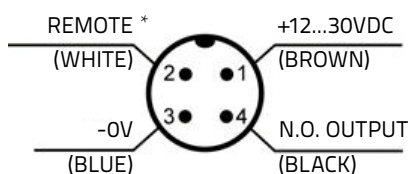

M8 CONNECTOR

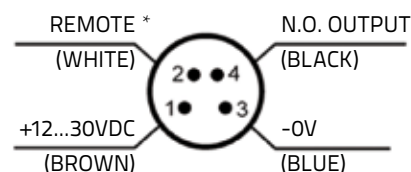

* REMOTE INPUT (mod. S8...W, U, T50, T53), LIGHT / DARK INPUT (mod. S8...M53), DELAY (mod. S8...M Laser), TEST INPUT (mod. S8...G), ALARM OUTPUT (mod. S8...B, T51), NOT USED (mod. S8...C, M, F)

DIMENSIONS

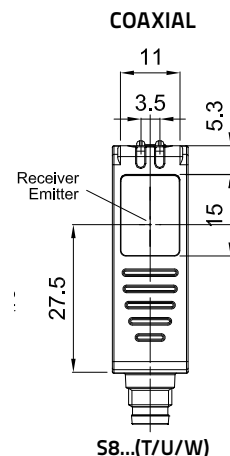
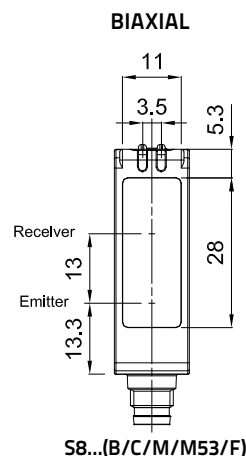
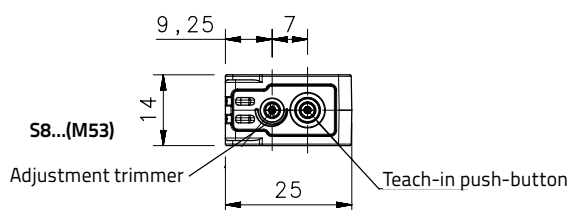
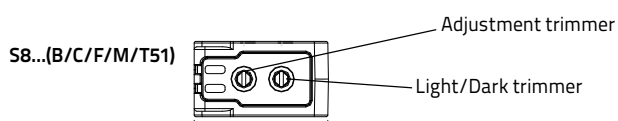
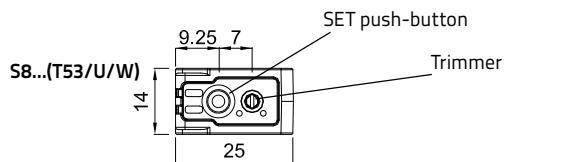
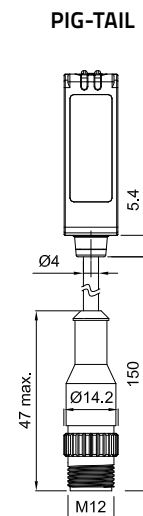
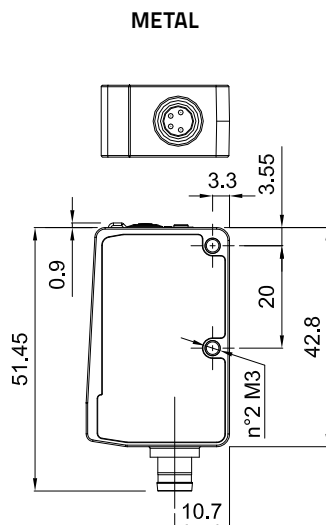
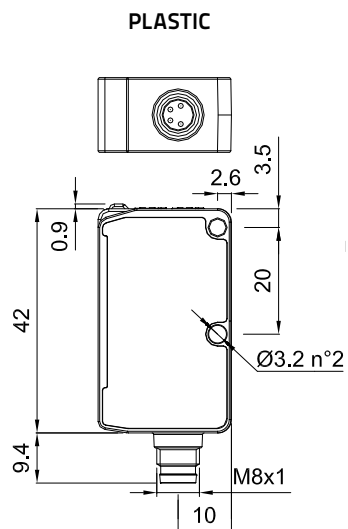

INDICATOR AND SETTING

S8...M / B / C / T01

S8...W / T53

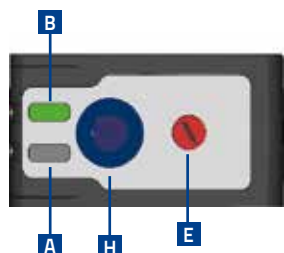
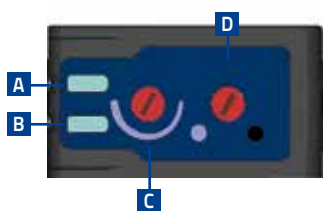

- A** Output status LED
- B** Ready LED or Power ON LED
- C** Sensitivity adjustment trimmer
- D** Dark/light trimmer

- E** Delay trimmer
- F** M8 connector
- G** M12 pig-tail connector
- H** SET push-button

READING DIAGRAMS

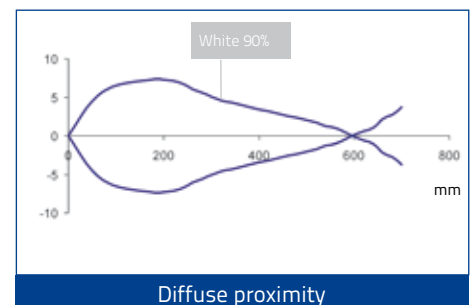
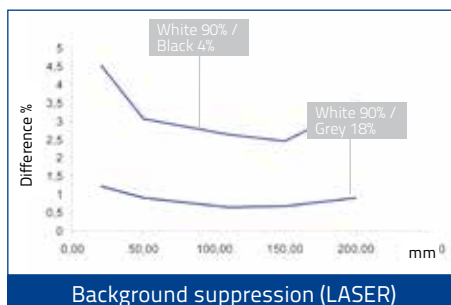
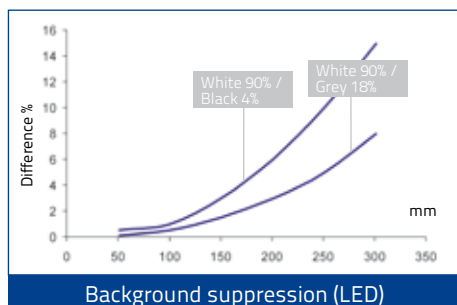
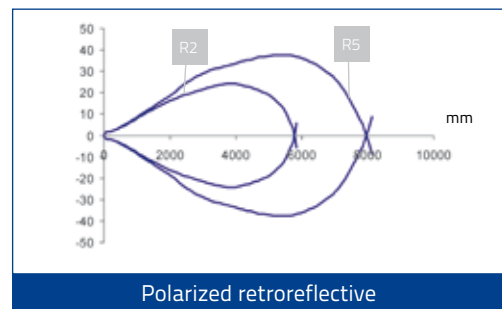
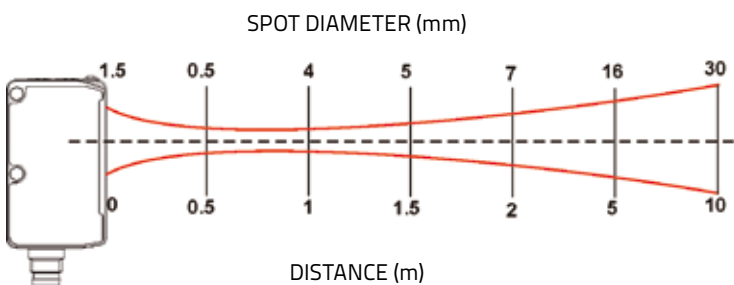
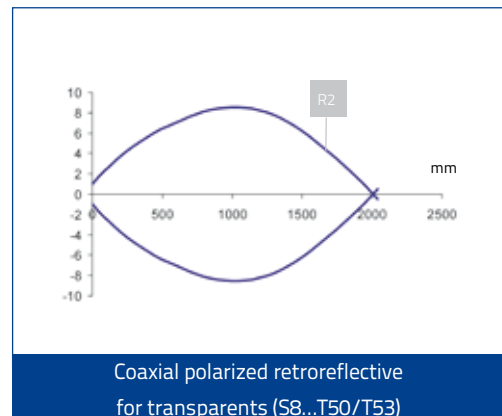
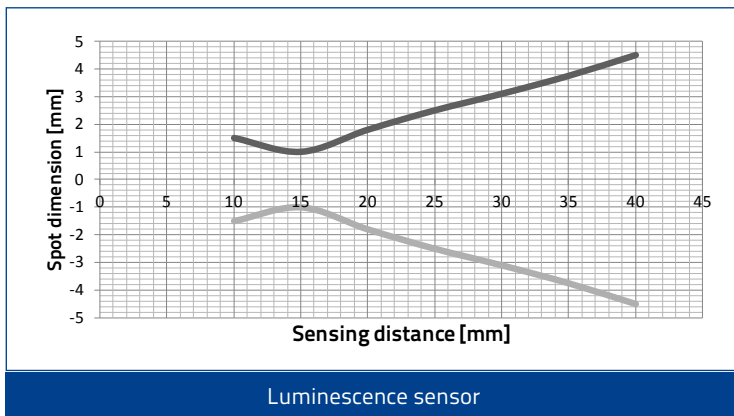
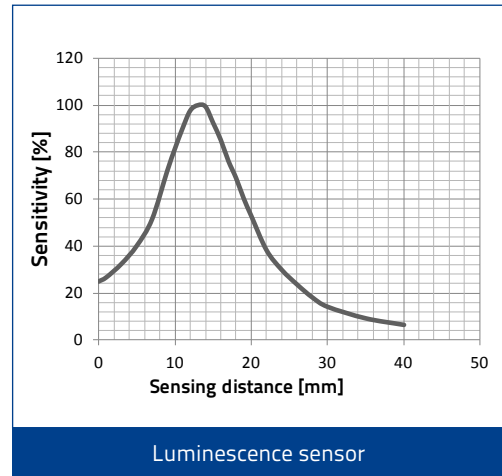
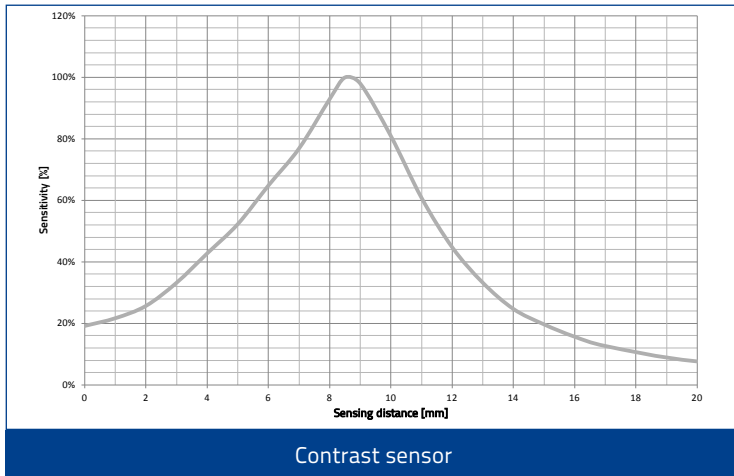

MODEL SELECTION AND ORDER INFORMATION

CLEAR DETECTION					
HOUSING	LIGHT EMISSION	CONNECTION	OUTPUT	MODEL	ORDER NO.
METAL Stainless Steel (INOX AISI346L)	LASER	M8 connector	PNP	S8-MH-5-M53-PP	950801450
	LED			S8-MR-5-M53-PP	950801600
PLASTIC ABS	LASER			S8-PH-5-M53-PP	950801380
	LED			S8-PR-5-M53-PP	950801590

RETROREFLECTIVE FOR TRASPARENT					
HOUSING	LIGHT EMISSION	CONNECTION	OUTPUT	MODEL	ORDER NO.
METAL Stainless Steel (INOX AISI346L)	LED	M8 connector	NPN	S8-MR-5-T50-NH	950801330
			PNP	S8-MR-5-T50-PH	950801320
		M8 connector with auto-adjustment function	NPN	S8-MR-5-T53-NN	950801310
			PNP	S8-MR-5-T53-PP	950801300
PLASTIC ABS		pig-tail	NPN	S8-PR-3-T51-NN	950801130
			PNP	S8-PR-3-T51-PP	950801120
		M8 connector	NPN	S8-PR-5-T51-NN	950801050
			PNP	S8-PR-5-T51-PP	950801040
	NPN		S8-PR-5-T53-NN	950801290	
	PNP		S8-PR-5-T53-PP	950801280	

POLARIZED RETROREFLECTIVE					
HOUSING	LIGHT EMISSION	CONNECTION	OUTPUT	MODEL	ORDER NO.
METAL Stainless Steel (INOX AISI346L)	LASER	M8 connector	NPN	S8-MH-5-B51-NN	950801490
			PNP	S8-MH-5-B51-PP	950801480
	LED		NPN	S8-MR-5-B01-NN	950801420
			PNP	S8-MR-5-B01-PP	950801410
PLASTIC ABS	LASER	pig-tail	NPN	S8-PH-3-B51-NN	950801090
			PNP	S8-PH-3-B51-PP	950801080
		M8 connector	NPN	S8-PH-5-B51-NN	950801010
			PNP	S8-PH-5-B51-PP	950801000
	LED	pig-tail	NPN	S8-PR-3-B01-NN	950801190
			PNP	S8-PR-3-B01-PP	950801180
		M8 connector	NPN	S8-PR-5-B01-NN	950801170
			PNP	S8-PR-5-B01-PP	950801160

BACKGROUND SUPPRESSION					
HOUSING	LIGHT EMISSION	CONNECTION	OUTPUT	MODEL	ORDER NO.
METAL Stainless Steel (INOX AISI346L)	LASER	M8 connector	NPN	S8-MH-5-M01-NN	950801470
			PNP	S8-MH-5-M01-PP	950801460
	LED		NPN	S8-MR-5-M01-NN	950801400
			PNP	S8-MR-5-M01-PP	950801390
PLASTIC ABS	LASER	pig-tail	NPN	S8-PH-3-M01-NN	950801110
			PNP	S8-PH-3-M01-PP	950801100
		M8 connector	NPN	S8-PH-5-M01-NN	950801030
			PNP	S8-PH-5-M01-PP	950801020
	LED	pig-tail	NPN	S8-PR-3-M01-NN	950801230
			PNP	S8-PR-3-M01-PP	950801220
		M8 connector	NPN	S8-PR-5-M01-NN	950801210
			PNP	S8-PR-5-M01-PP	950801200

THROUGH BEAM					
HOUSING	LIGHT EMISSION	CONNECTION	OUTPUT	MODEL	ORDER NO.
METAL Stainless Steel (INOX AISI316L)	LED	M8 connector	NPN	S8-MR-5-F01-NN	950801570
			PNP	S8-MR-5-F01-PP	950801560
			emitter	S8-MR-5-G00-XG	950801580
PLASTIC ABS		pig-tail	NPN	S8-PR-3-F01-NN	950801530
			PNP	S8-PR-3-F01-PP	950801520
			emitter	S8-PR-3-G00-XG	950801550
		M8 connector	NPN	S8-PR-5-F01-NN	950801510
			PNP	S8-PR-5-F01-PP	950801500
			emitter	S8-PR-5-G00-XG	950801540

DIFFUSE					
HOUSING	LIGHT EMISSION	CONNECTION	OUTPUT	MODEL	ORDER NO.
METAL Stainless Steel (INOX AISI316L)	LED	M8 connector	NPN	S8-MR-5-C01-NN	950801440
			PNP	S8-MR-5-C01-PP	950801430
PLASTIC ABS		pig-tail	NPN	S8-PR-3-C01-NN	950801270
			PNP	S8-PR-3-C01-PP	950801250
M8 connector		NPN	S8-PR-5-C01-NN	950801260	
		PNP	S8-PR-5-C01-PP	950801240	

CONTRAST					
SWITCHING FREQUENCY	HOUSING	CONNECTION	OUTPUT	MODEL	ORDER NO.
10 kHz	METAL Stainless Steel	M8 connector without trimmer	PNP	S8-MR-5-W00-PH	950801360
			NPN	S8-MR-5-W00-NH	950801370
		M8 connector	PNP	S8-MR-5-W03-PP	950801340
	PLASTIC ABS	M12 pig-tail (150 mm)	NPN	S8-MR-5-W03-NN	950801350
			PNP	S8-PR-3-W03-PP	950801140
		M8 connector	NPN	S8-PR-3-W03-NN	950801150
25 kHz	METAL Stainless Steel	M8 connector	PNP	S8-PR-5-W03-PP	950801060
			NPN	S8-PR-5-W03-NN	950801070
			PNP	S8-MR-5-W13-PP	950801670
	NPN		S8-MR-5-W13-NN	950801680	
	PLASTIC ABS		PNP	S8-PR-5-W13-PP	950801650
			NPN	S8-PR-5-W13-NN	950801660
M12 pig-tail (150 mm)		PNP	S8-PR-3-W13-PP	950801690	
NPN	S8-PR-3-W13-NN	950801700			

LUMINESCENCE					
HOUSING	SETTINGS	CONNECTION	OUTPUT	MODEL	ORDER NO.
METAL Stainless Steel	Teach-in push-button; L/D trimmer selector; Remote input	M8 connector	PNP	S8-MR-5-U03-PP	950801630
			NPN	S8-MR-5-U03-NN	950801640
PNP			S8-PR-5-U03-PP	950801610	
NPN			S8-PR-5-U03-NN	950801620	
PLASTIC ABS		pig-tail	PNP	S8-PR-3-U03-PP	950801710
			NPN	S8-PR-3-U03-NN	950801720

ST-5072

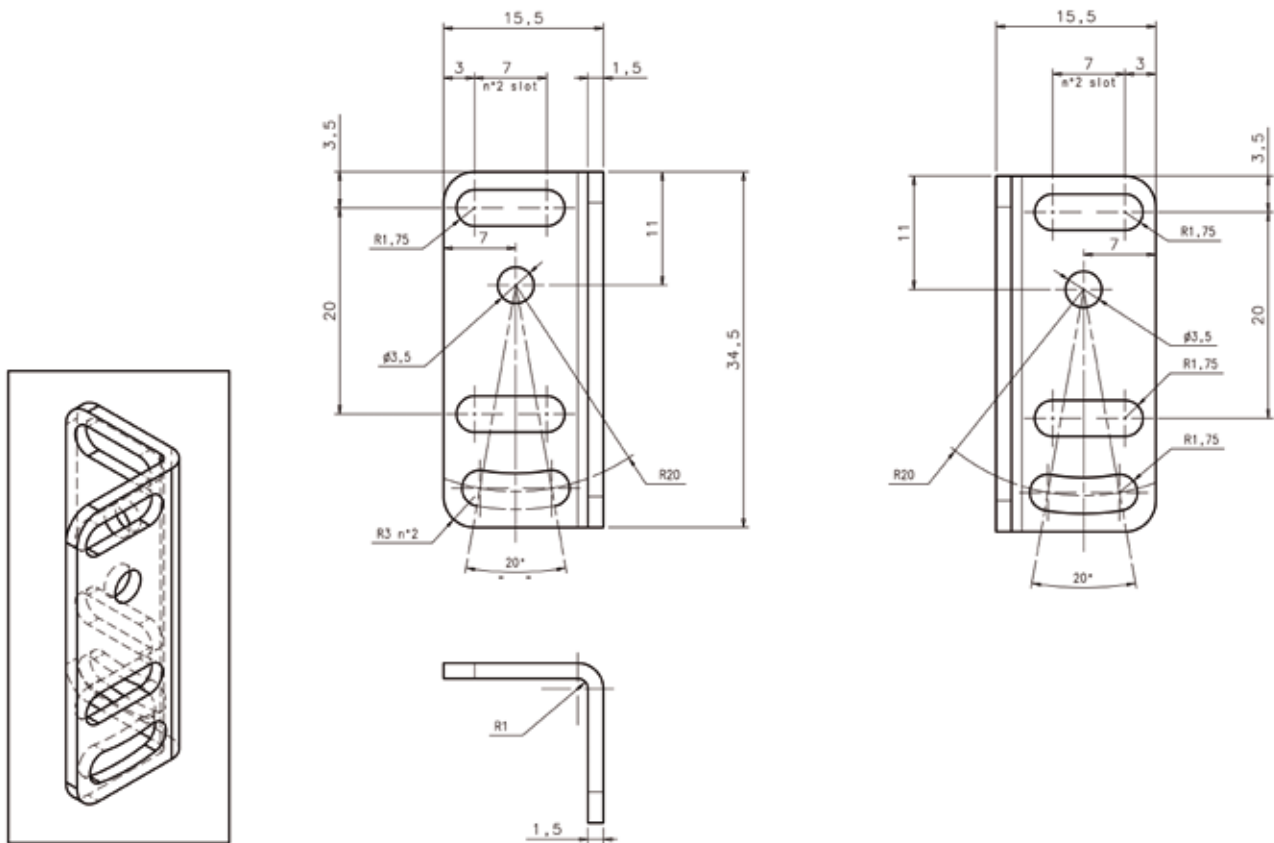

MODEL	FUNCTION	ORDER No.
ST-S8-FRM	mounting bracket for standard frame	95ACC7860
ST-5072	mounting bracket	95ACC1470
R4K	IP69K plastic reflector 51 x 61 mm	95A151220
ST-S8-TL-LD46	TL-LD46 adapting bracket	95ACC3430
ST-S8-S3Z	S8-miniature sensors adapting bracket	95ACC3440

CABLES

TYPE	DESCRIPTION	LENGTH	MODEL	ORDER No.
Axial M8 Connector	4-pole, grey, P.V.C.	3 m	CS-B1-02-G-03	95A251420
		5 m	CS-B1-02-G-05	95A251430
		7 m	CS-B1-02-G-07	95A251440
		10 m	CS-B1-02-G-10	95A251480
	4-pole, P.U.R.	2 m	CS-B1-02-R-02	95A251620
		5 m	CS-B1-02-R-05	95A251640
Radial M8 Connector	4-pole, grey, P.V.C.	3 m	CS-B2-02-G-03	95A251450
		5 m	CS-B2-02-G-05	95A251460
		7 m	CS-B2-02-G-07	95A251470
		10 m	CS-B2-02-G-10	95A251530
	4-pole, P.U.R.	2 m	CS-B2-02-R-02	95A251630
		5 m	CS-B2-02-R-05	95A251650